

LM285-1.2, LM385-1.2, LM385B-1.2 MICROPOWER VOLTAGE REFERENCES

SLVS075C – APRIL 1989 – REVISED JULY 1999

- **Operating Current Range**
 - LM285 . . . 10 μ A to 20 mA
 - LM385 . . . 15 μ A to 20 mA
 - LM385B . . . 15 μ A to 20 mA
- **1% and 2% Initial Voltage Tolerance**
- **Reference Impedance**
 - LM385 . . . 1 Ω Max at 25°C
 - All Devices . . . 1.5 Ω Max Over Full Temperature Range
- **Very Low Power Consumption**
- **Applications:**
 - Portable Meter References
 - Portable Test Instruments
 - Battery-Operated Systems
 - Current-Loop Instrumentation
 - Panel Meters
- **Designed to be Interchangeable With National LM285-1.2 and LM385-1.2**

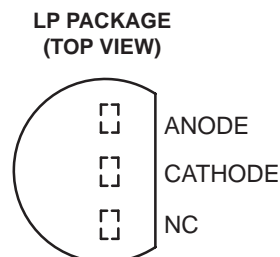
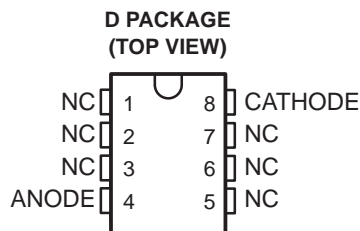

NC—No internal connection

description

These micropower, two-terminal, band-gap voltage references operate over a 10- μ A to 20-mA current range and feature exceptionally low dynamic impedance and good temperature stability. On-chip trimming provides tight voltage tolerance. The band-gap reference for these devices has low noise and long-term stability.

The design makes these devices exceptionally tolerant of capacitive loading and thus, easier to use in most reference applications. The wide dynamic operating temperature range accommodates varying current supplies with excellent regulation.

The extremely low power drain of this series makes them useful for micropower circuitry. These voltage references can be used to make portable meters, regulators, or general-purpose analog circuitry, with battery life approaching shelf life. The wide operating current range allows them to replace older references with tighter-tolerance parts.

The LM285-1.2 is characterized for operation from -40°C to 85°C . The LM385-1.2 and LM385B-1.2 are characterized for operation from 0°C to 70°C .

AVAILABLE OPTIONS

T _A	V _Z TOLERANCE	PACKAGED DEVICES†		CHIP FORM (Y)
		SMALL OUTLINE (D)	PLASTIC (LP)	
0°C to 70°C	2%	LM385D-1.2	LM385LP-1.2	LM385Y-1.2
	1%	LM385BD-1.2	LM385BLP-1.2	
-40°C to 85°C	1%	LM285D-1.2	LM285LP-1.2	

The D package is available taped and reeled. Add the suffix R to the device type (e.g., LM385DR-1-2).

The chip form is tested at T_A = 25°C.

† For ordering purposes, the decimal point in the part number must be replaced with a hyphen (i.e., show the -1.2 suffix as "-1-2").



Please be aware that an important notice concerning availability, standard warranty, and use in critical applications of Texas Instruments semiconductor products and disclaimers thereto appears at the end of this data sheet.

PRODUCTION DATA information is current as of publication date. Products conform to specifications per the terms of Texas Instruments standard warranty. Production processing does not necessarily include testing of all parameters.

**TEXAS
INSTRUMENTS**

POST OFFICE BOX 655303 • DALLAS, TEXAS 75265

Copyright © 1999, Texas Instruments Incorporated

LM285-1.2, LM385-1.2, LM385B-1.2 MICROPOWER VOLTAGE REFERENCES

SLVS075C – APRIL 1989 – REVISED JULY 1999

symbol



schematic

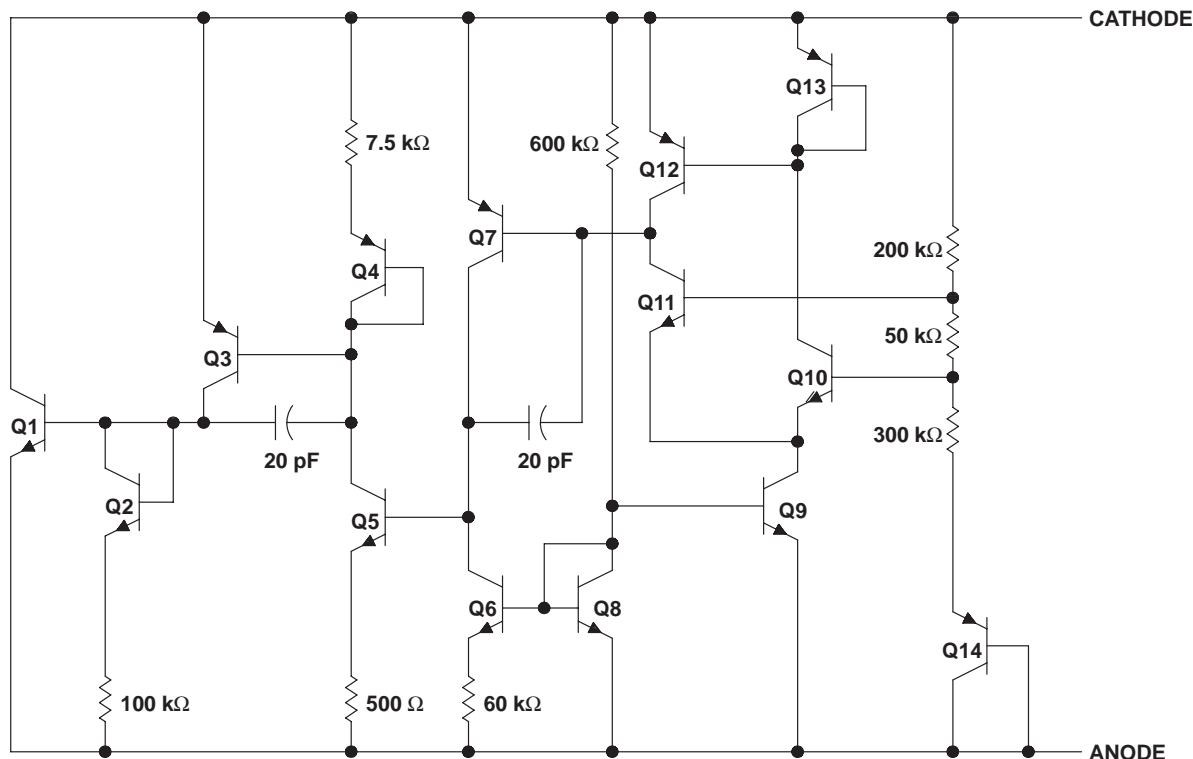

NOTE A: Component values shown are nominal.

absolute maximum ratings over operating free-air temperature range†

Reverse current, I_R	30 mA
Forward current, I_F	10 mA
Package thermal impedance, θ_{JA} (see Notes 1 and 2): D package	197°C/W
LP package	156°C/W
Lead temperature 1,6 mm (1/16 inch) from case for 10 seconds	260°C
Storage temperature range, T_{stg}	-65°C to 150°C

† Stresses beyond those listed under “absolute maximum ratings” may cause permanent damage to the device. These are stress ratings only, and functional operation of the device at these or any other conditions beyond those indicated under “recommended operating conditions” is not implied. Exposure to absolute-maximum-rated conditions for extended periods may affect device reliability.

- NOTES: 1. Maximum power dissipation is a function of $T_{J(max)}$, θ_{JA} , and T_A . The maximum allowable power dissipation at any allowable ambient temperature is $P_D = (T_{J(max)} - T_A)/\theta_{JA}$. Operation at the absolute maximum T_J of 150°C can impact reliability.
2. The package thermal impedance is calculated in accordance with JESD51, except for through-hole packages which use a trace length of zero.

recommended operating conditions

		MIN	MAX	UNIT
Reference current, I_Z		0.01	20	mA
Operating free-air temperature range, T_A	LM285-1.2	-40	85	°C
	LM385-1.2, LM385B-1.2	0	70	



POST OFFICE BOX 655303 • DALLAS, TEXAS 75265

LM285-1.2, LM385-1.2, LM385B-1.2 MICROPOWER VOLTAGE REFERENCES

SLVS075C – APRIL 1989 – REVISED JULY 1999

electrical characteristics at specified free-air temperature

PARAMETER	TEST CONDITIONS	T _A [†]	LM285-1.2			LM385-1.2			LM385B-1.2			UNIT	
			MIN	TYP	MAX	MIN	TYP	MAX	MIN	TYP	MAX		
V _Z	Reference voltage	I _Z = I(min) to 20 mA [‡]	25°C	1.223	1.235	1.247	1.21	1.235	1.26	1.223	1.235	1.247	V
αV _Z	Average temperature coefficient of reference voltage [§]	I _Z = I(min) to 20 mA [‡]	25°C	±20			±20			±20			ppm/°C
ΔV _Z	Change in reference voltage with current	I _Z = I(min) to 1 mA [‡]	25°C	1			1			1			mV
			Full range	1.5			1.5			1.5			
		I _Z = 1 mA to 20 mA	25°C	12			20			20			
			Full range	30			30			30			
ΔV _Z /Δt	Long-term change in reference voltage	I _Z = 100 μA	25°C	±20			±20			±20			ppm/khr
I _Z (min)	Minimum reference current		Full range	8 10			8 15			8 15			μA
z _Z	Reference impedance	I _Z = 100 μA, f = 25 Hz	25°C	0.2 0.6			0.4 1			0.4 1			Ω
			Full range	1.5			1.5			1.5			
V _n	Broadband noise voltage	I _Z = 100 μA, f = 10 Hz to 10 kHz	25°C	60			60			60			μV

[†] Full range is –40°C to 85°C for the LM285-1.2, and 0°C to 70°C for the LM385-1.2 and LM385B-1.2.

[‡] I(min) = 10 μA for the LM285-1.2 and 15 μA for the LM385-1.2 and LM385B-1.2.

[§] The average temperature coefficient of reference voltage is defined as the total change in reference voltage divided by the specified temperature range.

electrical characteristics, T_A = 25°C

PARAMETER	TEST CONDITIONS	LM385Y-1.2			UNIT
		MIN	TYP	MAX	
V _Z	Reference voltage	I _Z = 15 μA to 20 mA			V
αV _Z	Average temperature coefficient of reference voltage [§]	I _Z = 15 μA to 20 mA			ppm/°C
ΔV _Z	Change in reference voltage with current	I _Z = 15 μA to 1 mA			1
		I _Z = 1 mA to 20 mA			20
ΔV _Z /Δt	Long-term change in reference voltage	I _Z = 100 μA			ppm/khr
I _Z (min)	Minimum reference current				8 15
z _Z	Reference impedance	I _Z = 100 μA			Ω
V _n	Broadband noise voltage	I _Z = 100 μA, f = 10 Hz to 10 kHz			μV

[§] The average temperature coefficient of reference voltage is defined as the total change in reference voltage divided by the specified temperature range.



LM285-1.2, LM385-1.2, LM385B-1.2 MICROPOWER VOLTAGE REFERENCES

SLVS075C – APRIL 1989 – REVISED JULY 1999

TYPICAL CHARACTERISTICS†

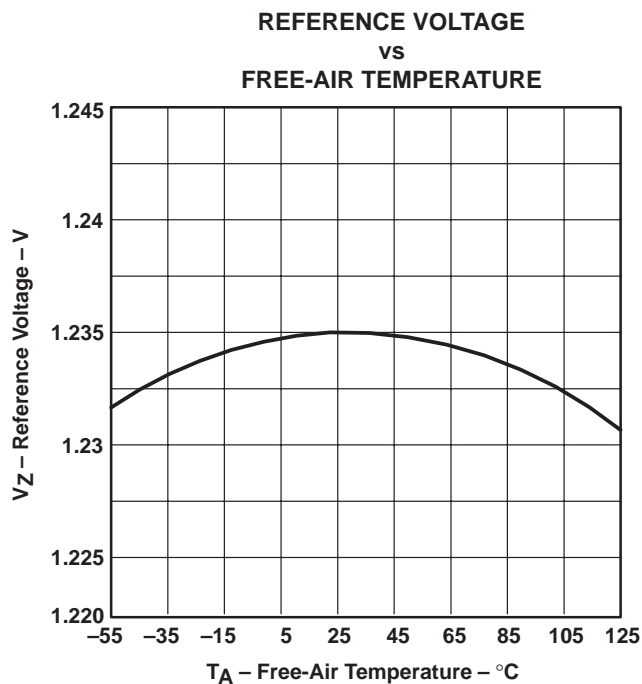
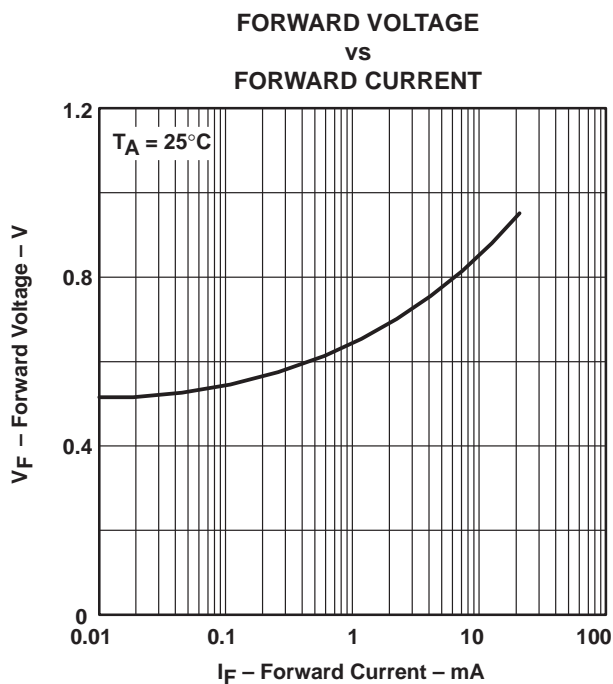
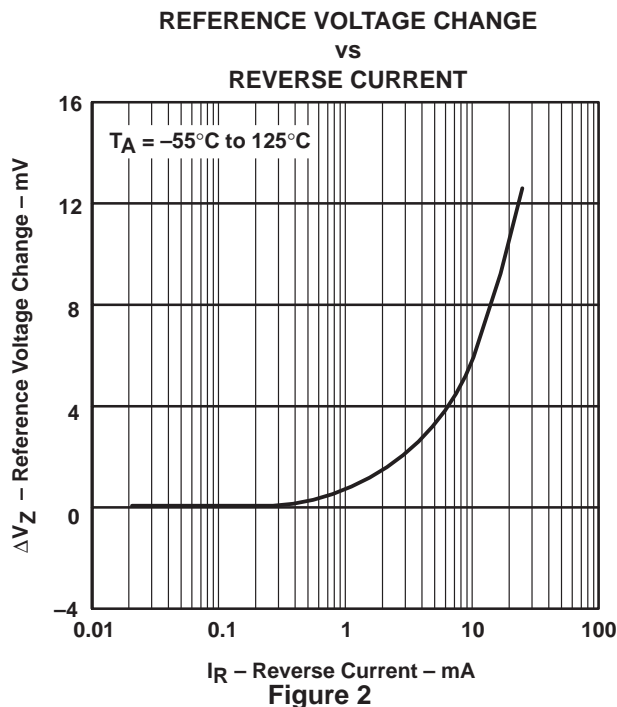
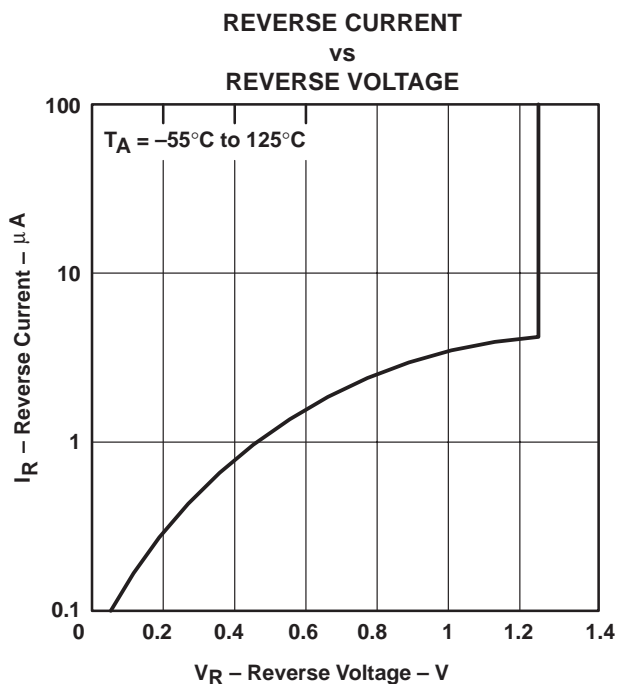

† Data at high and low temperatures are applicable only within the rated operating free-air temperature ranges of the various devices.



TYPICAL CHARACTERISTICS†

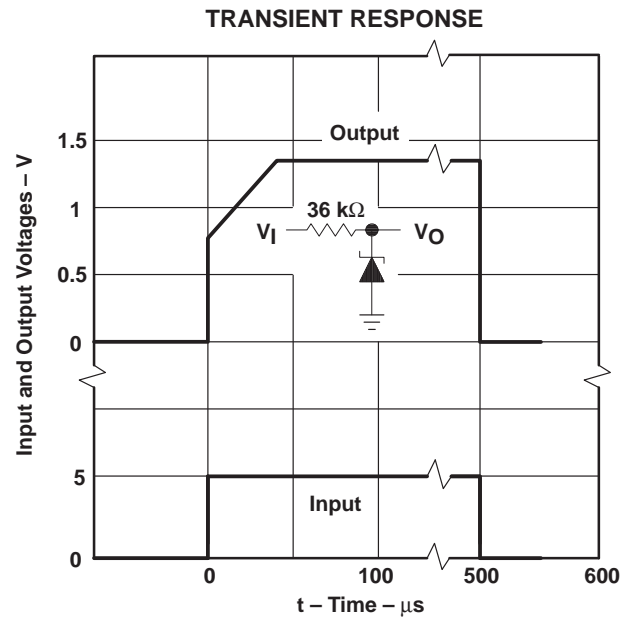
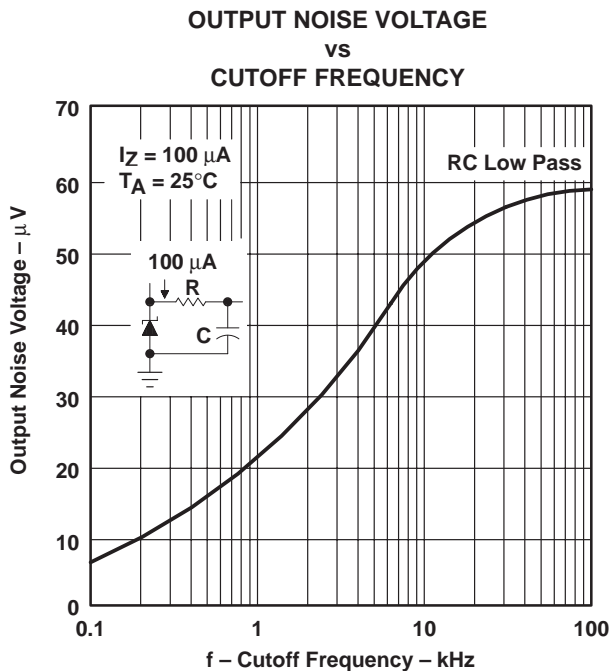
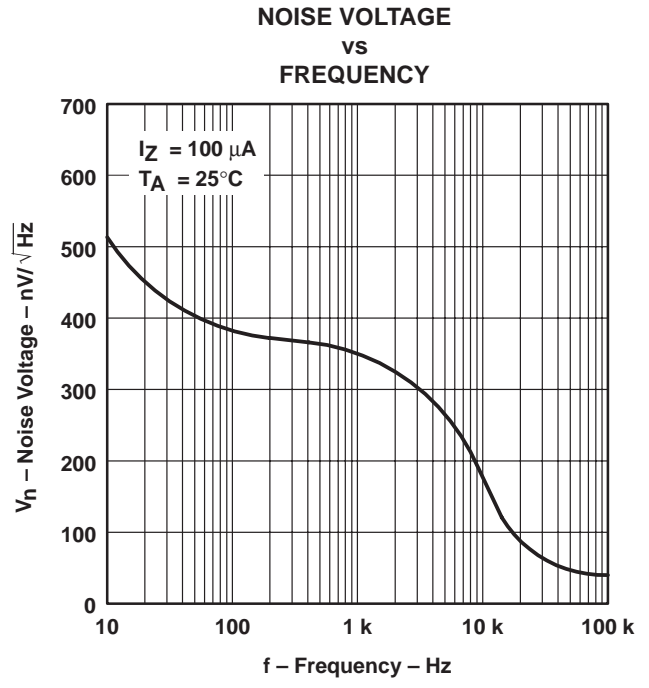
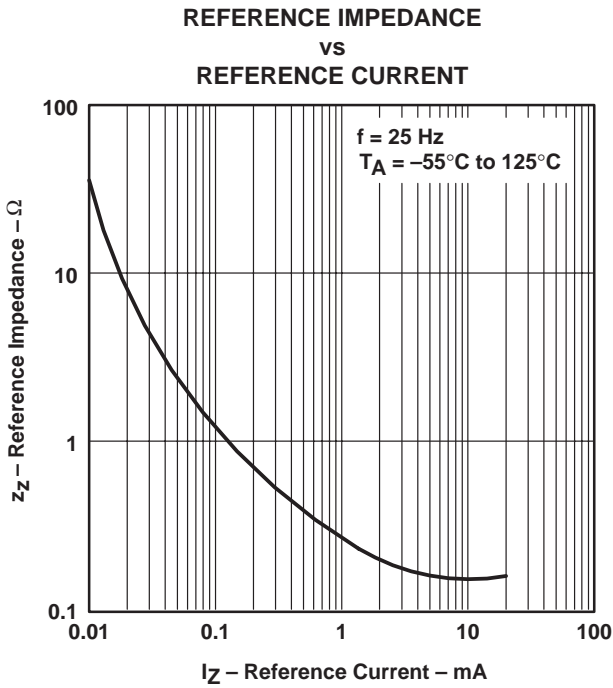

† Data at high and low temperatures are applicable only within the rated operating free-air temperature ranges of the various devices.

LM285-1.2, LM385-1.2, LM385B-1.2 MICROPOWER VOLTAGE REFERENCES

SLVS075C – APRIL 1989 – REVISED JULY 1999

APPLICATION INFORMATION

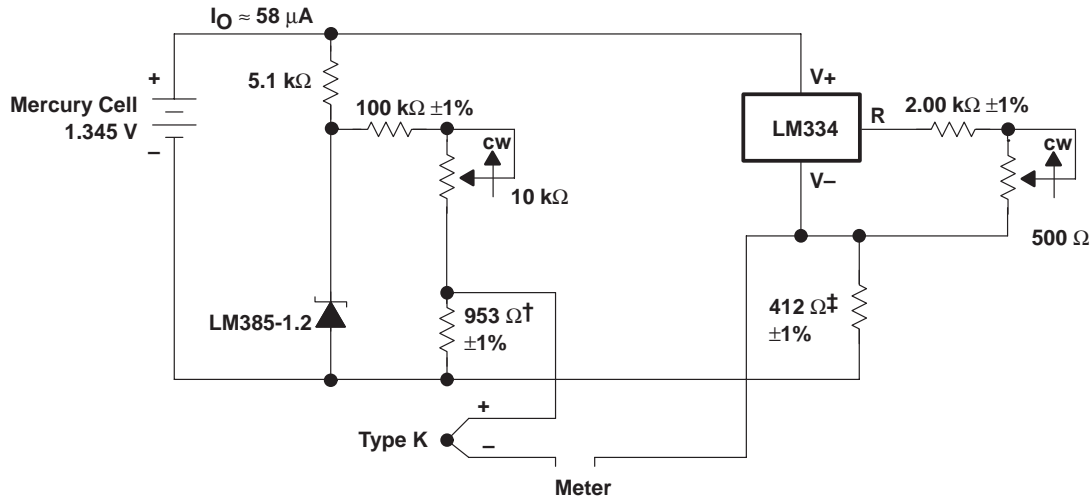

† Adjust for 11.15 mV at 25°C across 953 Ω

‡ Adjust for 12.17 mV at 25°C across 412 Ω

Figure 9. Thermocouple Cold-Junction Compensator

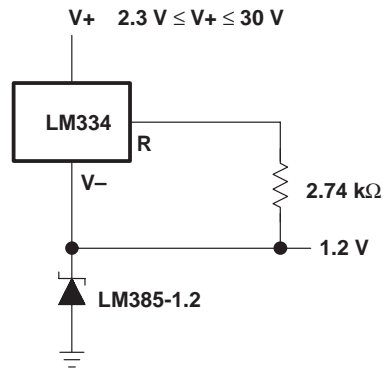

Figure 10. Operation Over a Wide Supply Range

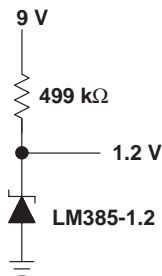

Figure 11. Reference From a 9-V Battery

IMPORTANT NOTICE

Texas Instruments and its subsidiaries (TI) reserve the right to make changes to their products or to discontinue any product or service without notice, and advise customers to obtain the latest version of relevant information to verify, before placing orders, that information being relied on is current and complete. All products are sold subject to the terms and conditions of sale supplied at the time of order acknowledgement, including those pertaining to warranty, patent infringement, and limitation of liability.

TI warrants performance of its semiconductor products to the specifications applicable at the time of sale in accordance with TI's standard warranty. Testing and other quality control techniques are utilized to the extent TI deems necessary to support this warranty. Specific testing of all parameters of each device is not necessarily performed, except those mandated by government requirements.

CERTAIN APPLICATIONS USING SEMICONDUCTOR PRODUCTS MAY INVOLVE POTENTIAL RISKS OF DEATH, PERSONAL INJURY, OR SEVERE PROPERTY OR ENVIRONMENTAL DAMAGE ("CRITICAL APPLICATIONS"). TI SEMICONDUCTOR PRODUCTS ARE NOT DESIGNED, AUTHORIZED, OR WARRANTED TO BE SUITABLE FOR USE IN LIFE-SUPPORT DEVICES OR SYSTEMS OR OTHER CRITICAL APPLICATIONS. INCLUSION OF TI PRODUCTS IN SUCH APPLICATIONS IS UNDERSTOOD TO BE FULLY AT THE CUSTOMER'S RISK.

In order to minimize risks associated with the customer's applications, adequate design and operating safeguards must be provided by the customer to minimize inherent or procedural hazards.

TI assumes no liability for applications assistance or customer product design. TI does not warrant or represent that any license, either express or implied, is granted under any patent right, copyright, mask work right, or other intellectual property right of TI covering or relating to any combination, machine, or process in which such semiconductor products or services might be or are used. TI's publication of information regarding any third party's products or services does not constitute TI's approval, warranty or endorsement thereof.